

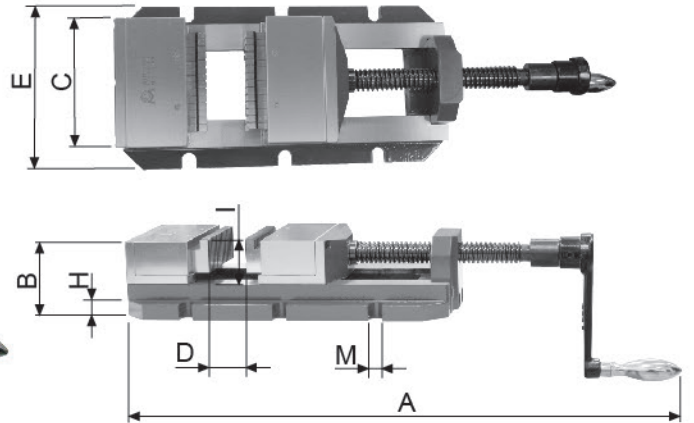

35014

魔術虎鉗 MAGICAL JAW VISE

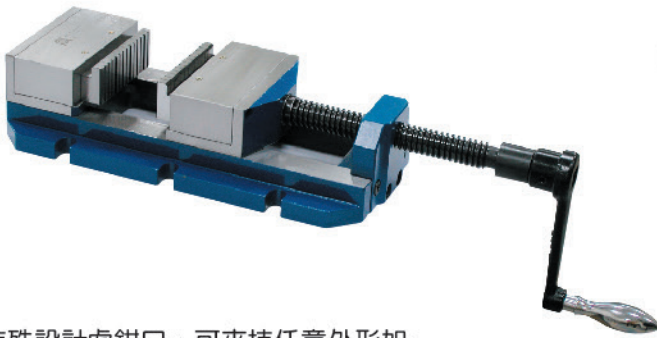

- 特殊設計虎鉗口，可夾持任意外形如：圓形、曲線形、多邊形等。
- 採用球狀石墨化鑄鐵FCD45製造，剛性強，不易變形。
- 虎鉗口夾持力: 1200kgf
- 虎鉗口材質:S50C，熱處理硬度HRC55°
- This vise associated with a swivel base can clamp workpiece in any shapes including round, polygon and angularity.
- Vise maximum clamping force 1200kgf.
- FCD-45 high malleable casting iron.
- Vise jaws made of S50C under HRC55° heat treatment.

● 曲線形夾持 Curve shape holding

● 圓形夾持 Round shape holding

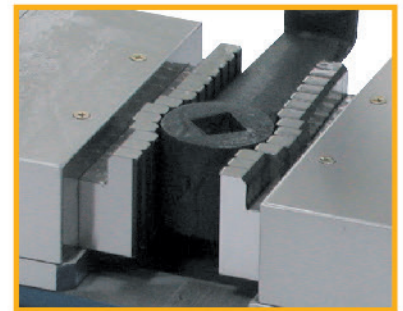
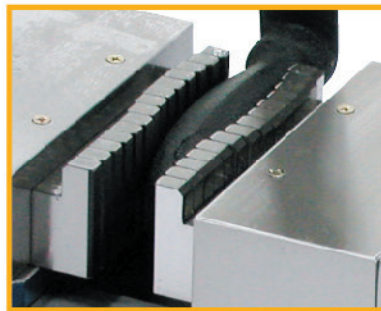

單位: mm

| 訂購編號<br>Order No. | 型號<br>Model | A       | B  | C   | D     | E   | H  | I  | M  | 重量(kg)<br>Weight |
|-------------------|-------------|---------|----|-----|-------|-----|----|----|----|------------------|
| 35014-13          | MV-130      | 450~572 | 81 | 127 | 0~122 | 170 | 35 | 46 | 14 | 18               |

35015

快速虎鉗 QUICK GRIP DRILL PRESS VISE

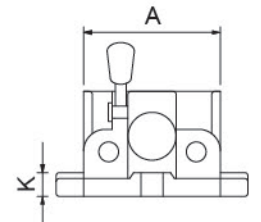
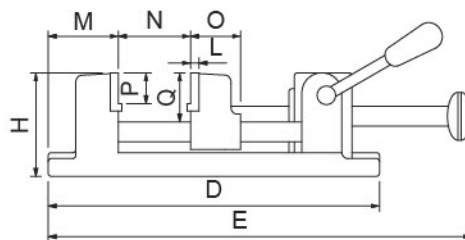
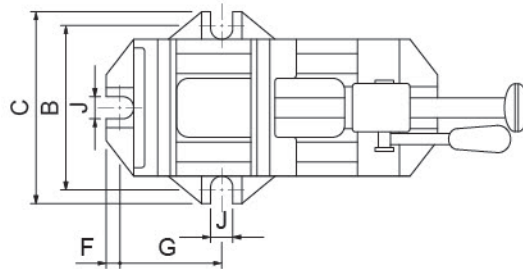
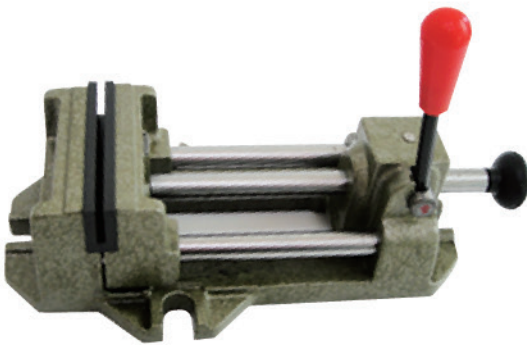

- 突破傳統螺桿式虎鉗調整設計，可快速變換開口大小。
- 材質：FC25強力鑄鐵。
- Breakthrough the traditional vise of screw adjust design，quickly change size of opening.
- Material: FC25 strength cast iron.

單位: mm

| 訂購編號<br>Order No. | 型號<br>Model | A   | B   | C   | D   | E   | F    | G   | H   | J  | K  | L | M  | N   | O    | P  | Q  | 重量(kg)<br>Weight |
|-------------------|-------------|-----|-----|-----|-----|-----|------|-----|-----|----|----|---|----|-----|------|----|----|------------------|
| 35015-30          | MCL-CK30    | 89  | 94  | 112 | 215 | 336 | 10.5 | 85  | 72  | 15 | 13 | 5 | 46 | 83  | 22   | 25 | 38 | 3.5              |
| 35015-40          | MCL-CK40    | 104 | 120 | 151 | 280 | 435 | 16   | 84  | 86  | 15 | 17 | 5 | 58 | 119 | 32.5 | 25 | 42 | 6.1              |
| 35015-60          | MCL-CK60    | 156 | 189 | 223 | 365 | 574 | 16   | 127 | 100 | 20 | 23 | 6 | 76 | 158 | 39   | 33 | 51 | 13.2             |
| 35015-80          | MCL-CK80    | 204 | 241 | 271 | 426 | 678 | 19   | 131 | 111 | 18 | 19 | 6 | 76 | 209 | 36   | 33 | 54 | 20.0             |